

6.003: Signals and Systems

Modulation

May 6, 2010

Communications Systems

Signals are not always well matched to the media through which we wish to transmit them.

signal

applications

audio

telephone, radio, phonograph, CD, cell phone, MP3

video

television, cinema, HDTV, DVD

internet

coax, twisted pair, cable TV, DSL, optical fiber, E/M

Amplitude Modulation

Amplitude modulation can be used to match audio frequencies to radio frequencies. It allows parallel transmission of multiple channels.

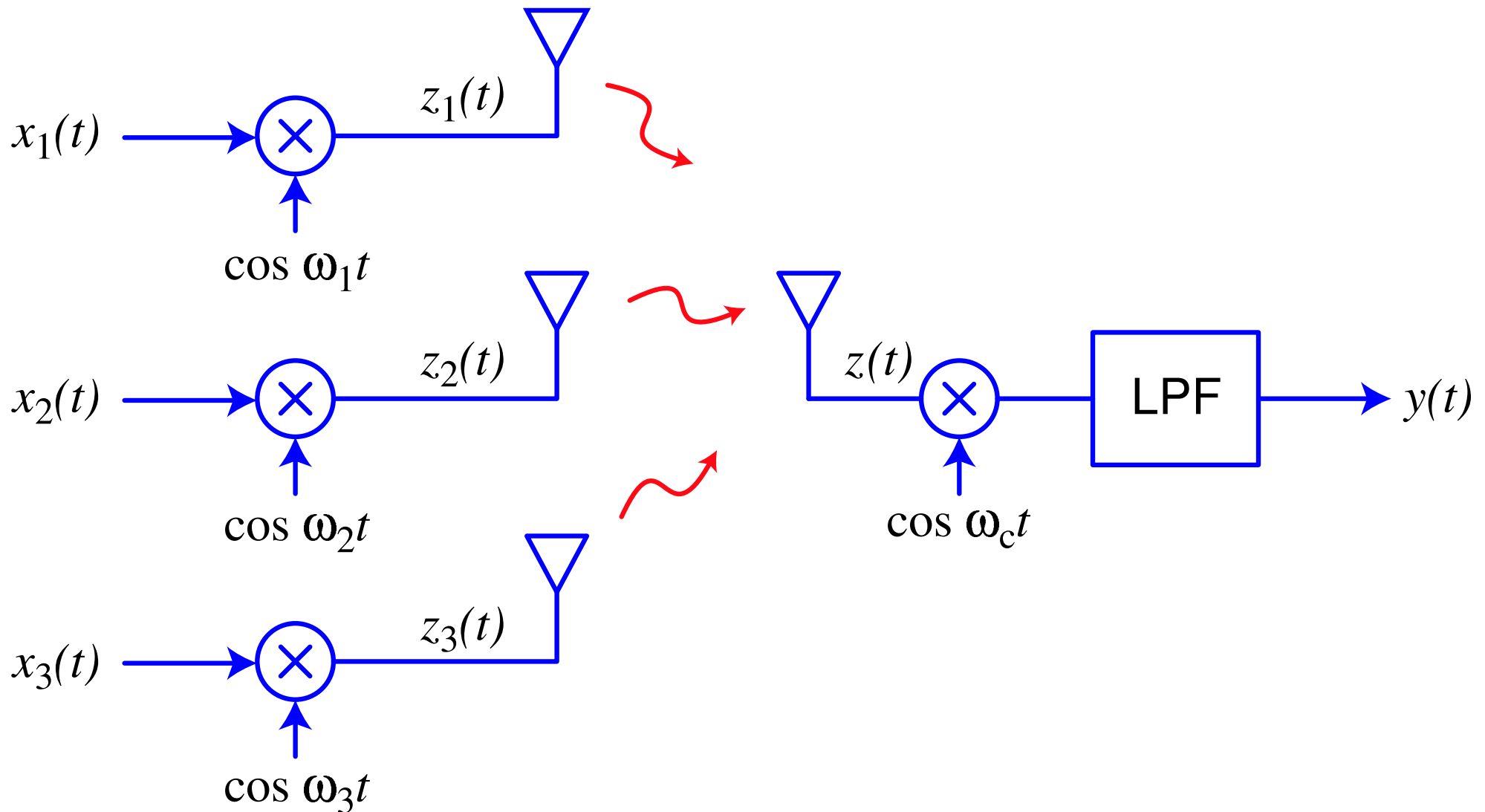

Superheterodyne Receiver

Edwin Howard Armstrong invented the superheterodyne receiver, which made broadcast AM practical.

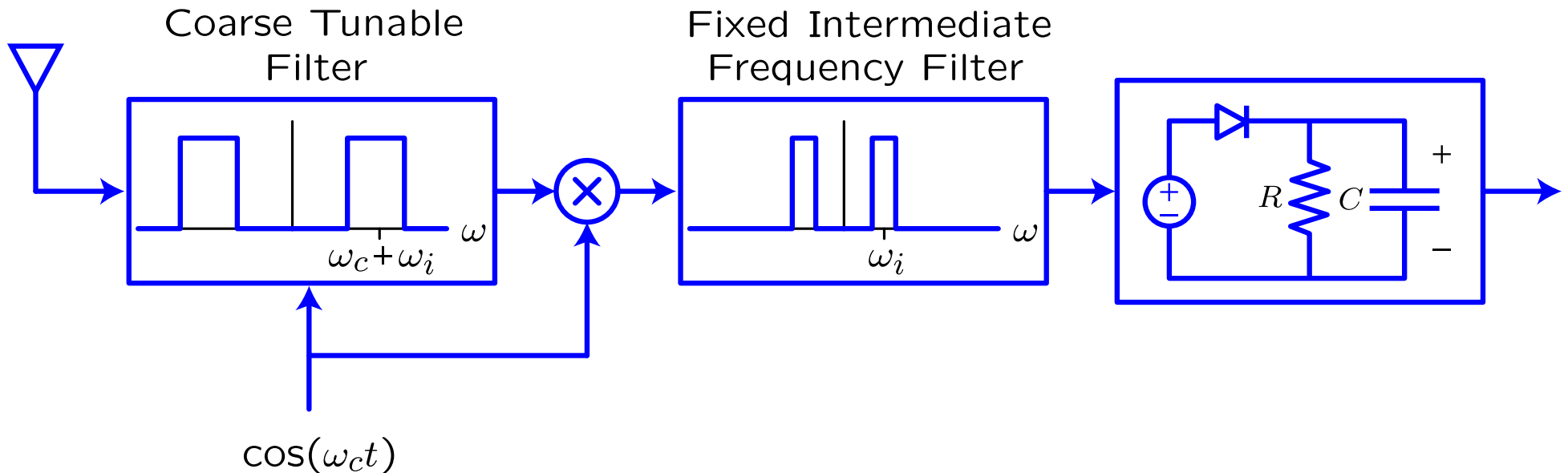

Edwin Howard Armstrong also invented and patented the “regenerative” (positive feedback) circuit for amplifying radio signals (while he was a junior at Columbia University). He also invented wide-band FM.

Amplitude, Phase, and Frequency Modulation

There are many ways to embed a “message” in a carrier. Here are three.

Amplitude Modulation (AM): $y_1(t) = x(t) \cos(\omega_c t)$

Phase Modulation (PM): $y_2(t) = \cos(\omega_c t + kx(t))$

Frequency Modulation (FM): $y_3(t) = \cos\left(\omega_c t + k \int_{-\infty}^t x(\tau) d\tau\right)$

Frequency Modulation

In FM, the signal modulates the instantaneous carrier frequency.

$$y_3(t) = \cos \left(\omega_c t + \underbrace{k \int_{-\infty}^t x(\tau) d\tau}_{\phi(t)} \right)$$

$$\omega_i(t) = \omega_c + \frac{d}{dt} \phi(t) = \omega_c + kx(t)$$

Frequency Modulation

Compare AM to FM for $x(t) = \cos(\omega_m t)$.

AM: $y_1(t) = (\cos(\omega_m t) + 1.1) \cos(\omega_c t)$

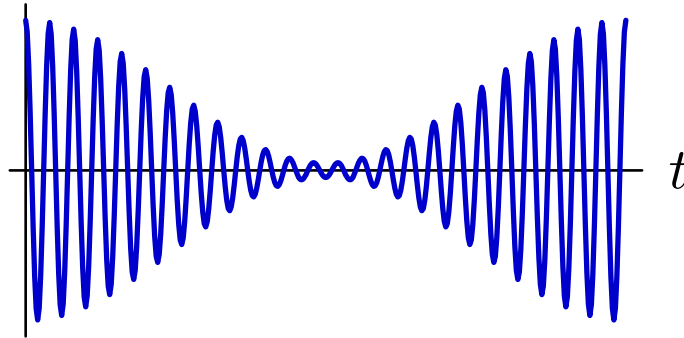

FM: $y_3(t) = \cos(\omega_c t + m \sin(\omega_m t))$

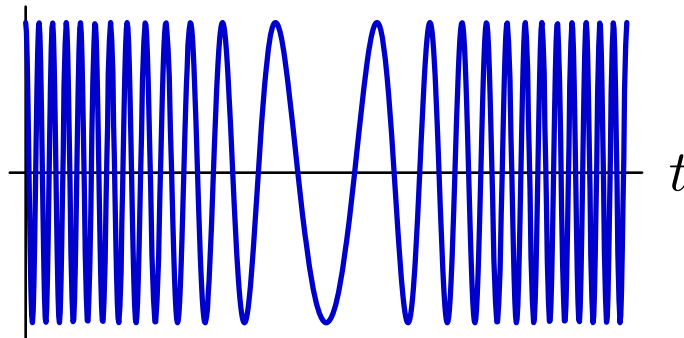

Advantages of FM:

- constant power
- no need to transmit carrier (unless DC important)
- bandwidth?

Frequency Modulation

Early investigators thought that narrowband FM could have arbitrarily narrow bandwidth, allowing more channels than AM. Wrong!

$$\begin{aligned}y_3(t) &= \cos\left(\omega_c t + k \int_{-\infty}^t x(\tau) d\tau\right) \\ &= \cos(\omega_c t) \times \cos\left(k \int_{-\infty}^t x(\tau) d\tau\right) - \sin(\omega_c t) \times \sin\left(k \int_{-\infty}^t x(\tau) d\tau\right)\end{aligned}$$

If $k \rightarrow 0$ then

$$\cos\left(k \int_{-\infty}^t x(\tau) d\tau\right) \rightarrow 1$$

$$\sin\left(k \int_{-\infty}^t x(\tau) d\tau\right) \rightarrow k \int_{-\infty}^t x(\tau) d\tau$$

$$y_3(t) \approx \cos(\omega_c t) - \sin(\omega_c t) \times \left(k \int_{-\infty}^t x(\tau) d\tau\right)$$

Bandwidth of narrowband FM is the same as that of AM!
(integration does not change bandwidth)

Phase/Frequency Modulation

Find the Fourier transform of a PM signal.

$$x(t) = \sin(\omega_m t)$$

$$y(t) = \cos(\omega_c t + m x(t)) = \cos(\omega_c t + m \sin(\omega_m t))$$

$$= \cos(\omega_c t) \cos(m \sin(\omega_m t)) - \sin(\omega_c t) \sin(m \sin(\omega_m t))$$

$x(t)$ is periodic in $T = \frac{2\pi}{\omega_m}$, therefore $\cos(m \sin(\omega_m t))$ is periodic in T .

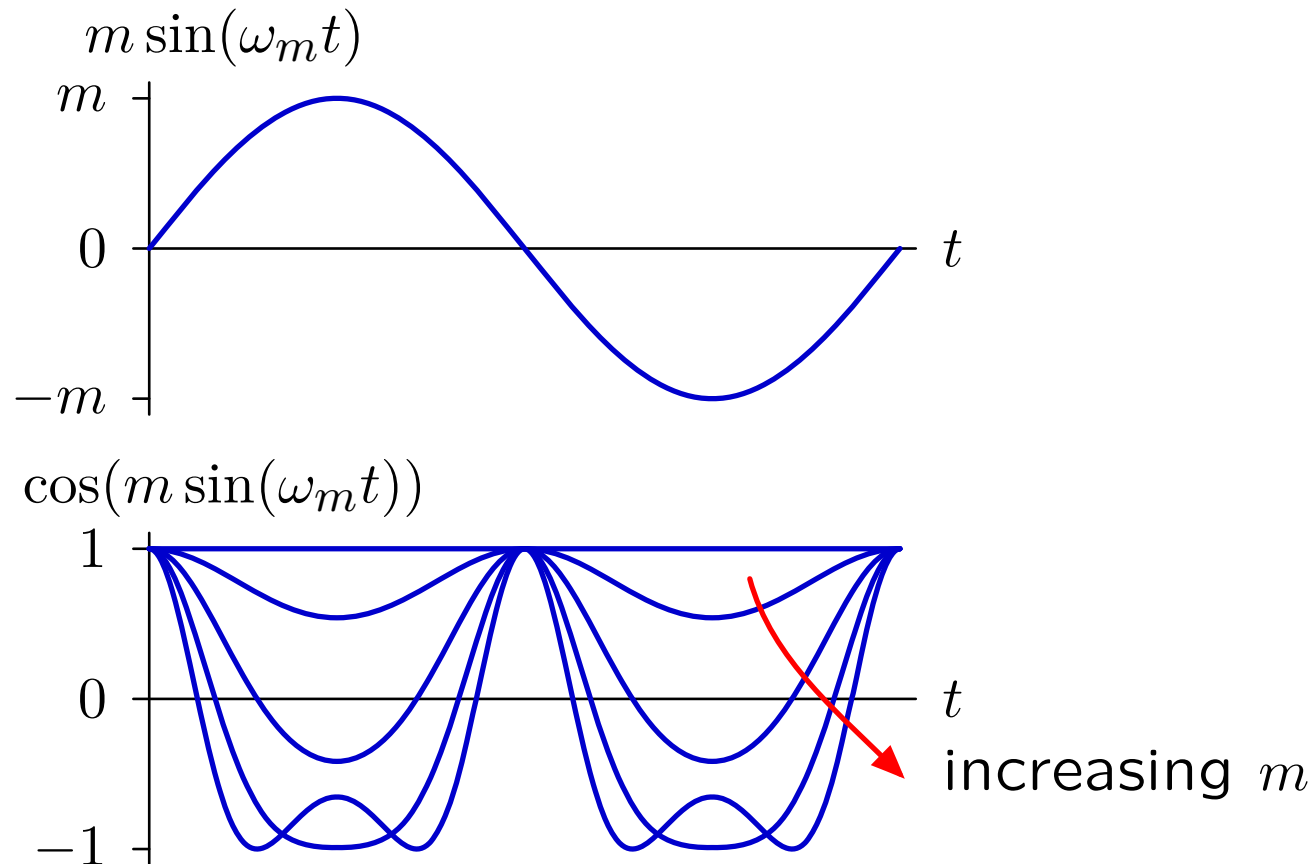

Phase/Frequency Modulation

Find the Fourier transform of a PM signal.

$$x(t) = \sin(\omega_m t)$$

$$y(t) = \cos(\omega_c t + m x(t)) = \cos(\omega_c t + m \sin(\omega_m t))$$

$$= \cos(\omega_c t) \cos(m \sin(\omega_m t)) - \sin(\omega_c t) \sin(m \sin(\omega_m t))$$

$x(t)$ is periodic in $T = \frac{2\pi}{\omega_m}$, therefore $\cos(m \sin(\omega_m t))$ is periodic in T .

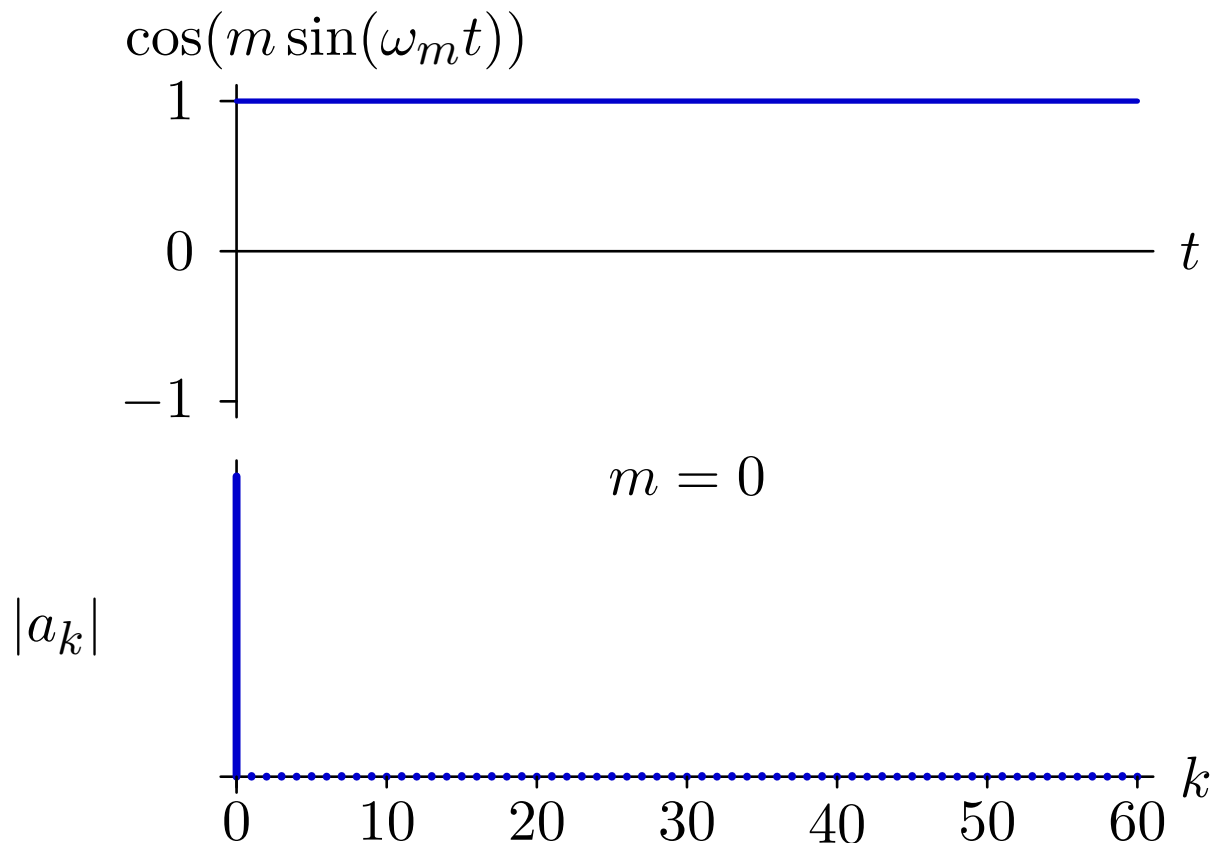

Phase/Frequency Modulation

Find the Fourier transform of a PM signal.

$$x(t) = \sin(\omega_m t)$$

$$y(t) = \cos(\omega_c t + m x(t)) = \cos(\omega_c t + m \sin(\omega_m t))$$

$$= \cos(\omega_c t) \cos(m \sin(\omega_m t)) - \sin(\omega_c t) \sin(m \sin(\omega_m t))$$

$x(t)$ is periodic in $T = \frac{2\pi}{\omega_m}$, therefore $\cos(m \sin(\omega_m t))$ is periodic in T .

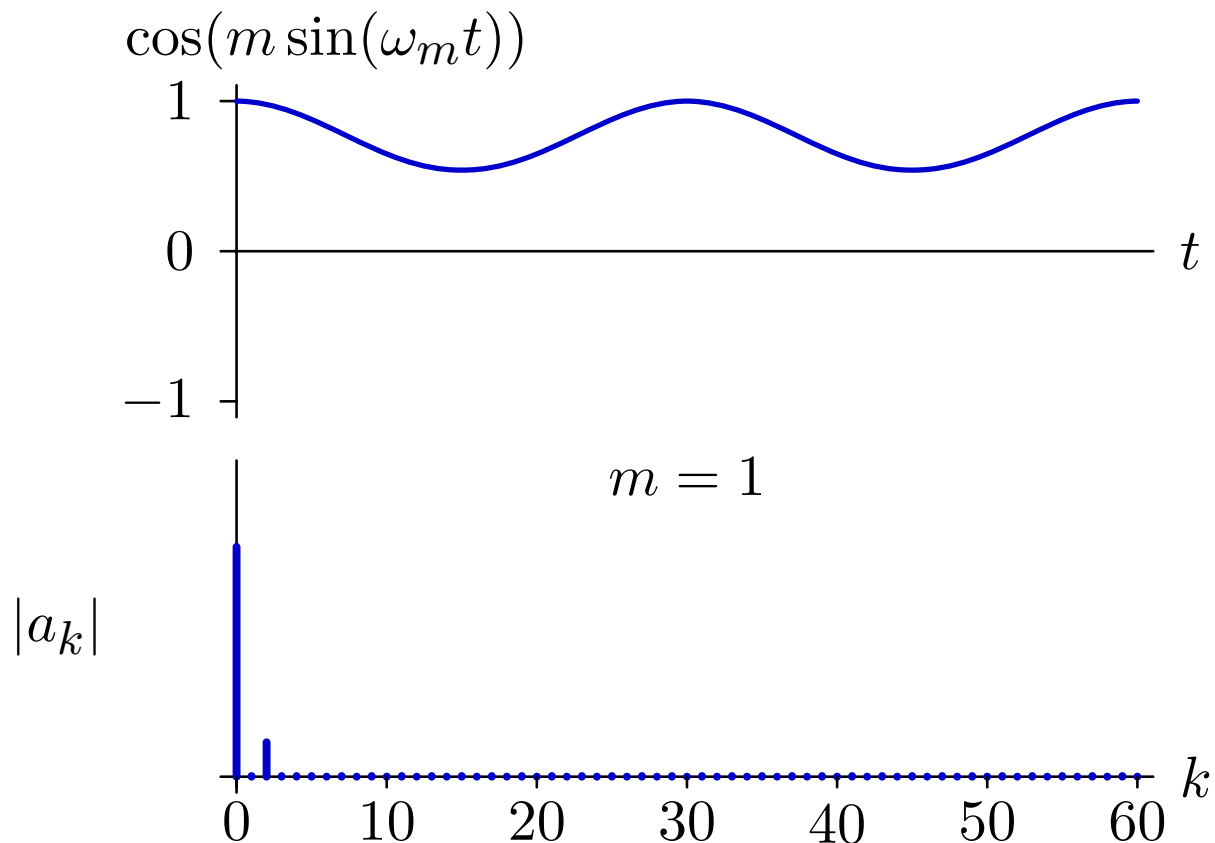

Phase/Frequency Modulation

Find the Fourier transform of a PM signal.

$$x(t) = \sin(\omega_m t)$$

$$y(t) = \cos(\omega_c t + m x(t)) = \cos(\omega_c t + m \sin(\omega_m t))$$

$$= \cos(\omega_c t) \cos(m \sin(\omega_m t)) - \sin(\omega_c t) \sin(m \sin(\omega_m t))$$

$x(t)$ is periodic in $T = \frac{2\pi}{\omega_m}$, therefore $\cos(m \sin(\omega_m t))$ is periodic in T .

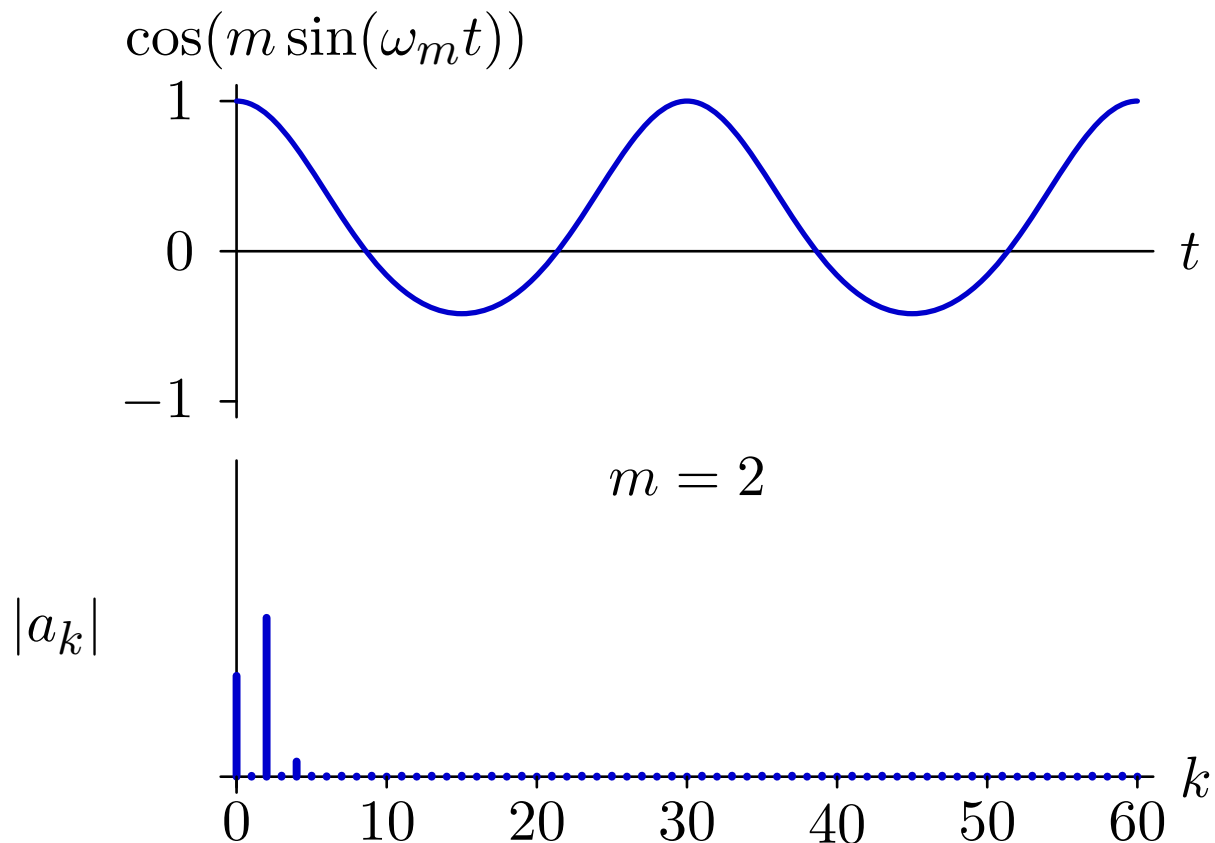

Phase/Frequency Modulation

Find the Fourier transform of a PM signal.

$$x(t) = \sin(\omega_m t)$$

$$y(t) = \cos(\omega_c t + m x(t)) = \cos(\omega_c t + m \sin(\omega_m t))$$

$$= \cos(\omega_c t) \cos(m \sin(\omega_m t)) - \sin(\omega_c t) \sin(m \sin(\omega_m t))$$

$x(t)$ is periodic in $T = \frac{2\pi}{\omega_m}$, therefore $\cos(m \sin(\omega_m t))$ is periodic in T .

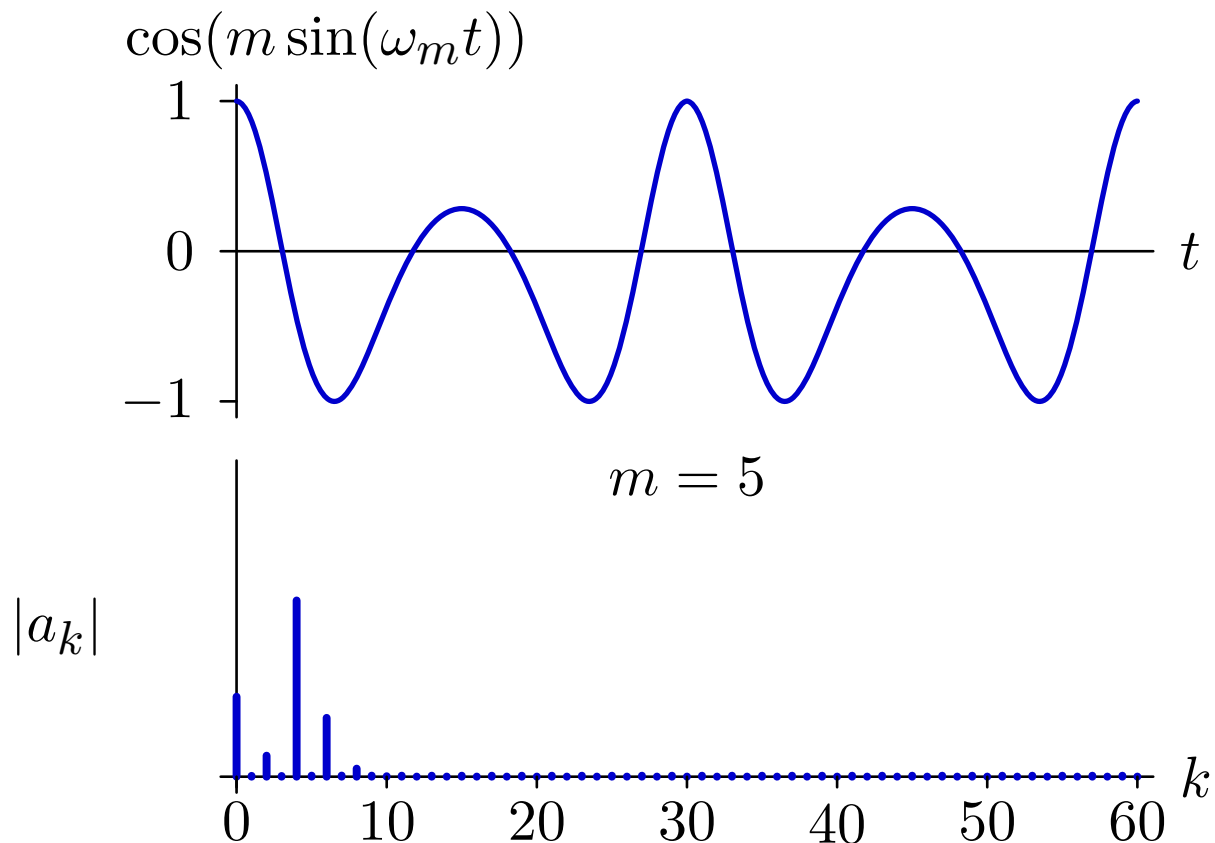

Phase/Frequency Modulation

Find the Fourier transform of a PM signal.

$$x(t) = \sin(\omega_m t)$$

$$y(t) = \cos(\omega_c t + m x(t)) = \cos(\omega_c t + m \sin(\omega_m t))$$

$$= \cos(\omega_c t) \cos(m \sin(\omega_m t)) - \sin(\omega_c t) \sin(m \sin(\omega_m t))$$

$x(t)$ is periodic in $T = \frac{2\pi}{\omega_m}$, therefore $\cos(m \sin(\omega_m t))$ is periodic in T .

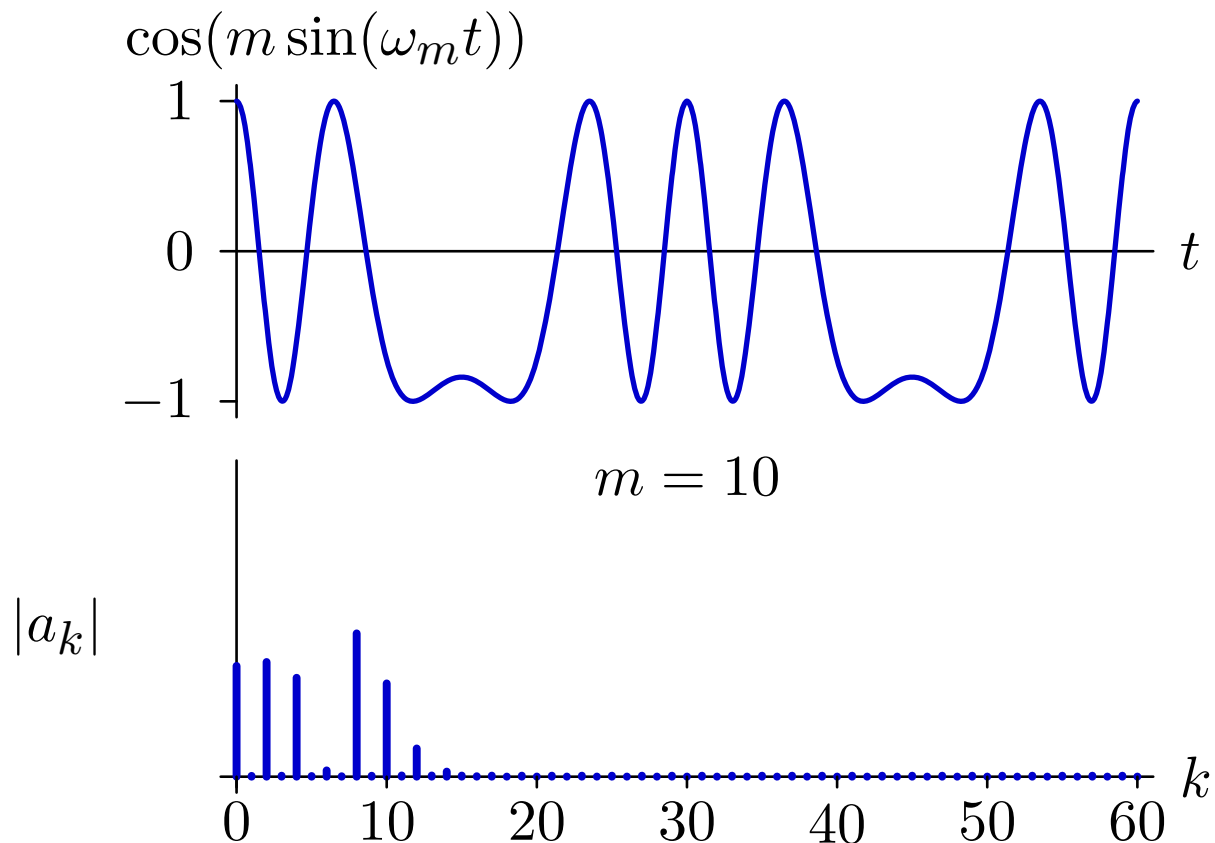

Phase/Frequency Modulation

Find the Fourier transform of a PM signal.

$$x(t) = \sin(\omega_m t)$$

$$y(t) = \cos(\omega_c t + m x(t)) = \cos(\omega_c t + m \sin(\omega_m t))$$

$$= \cos(\omega_c t) \cos(m \sin(\omega_m t)) - \sin(\omega_c t) \sin(m \sin(\omega_m t))$$

$x(t)$ is periodic in $T = \frac{2\pi}{\omega_m}$, therefore $\cos(m \sin(\omega_m t))$ is periodic in T .

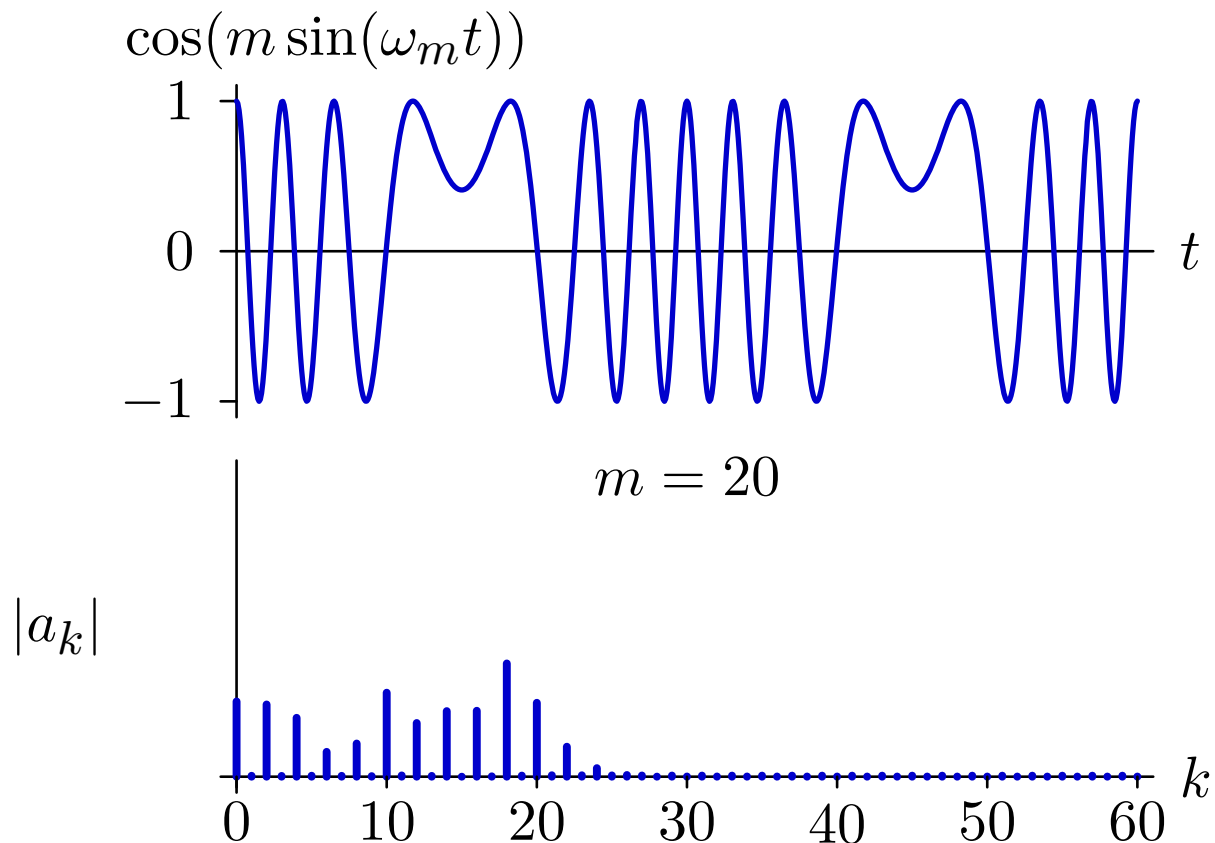

Phase/Frequency Modulation

Find the Fourier transform of a PM signal.

$$x(t) = \sin(\omega_m t)$$

$$y(t) = \cos(\omega_c t + m x(t)) = \cos(\omega_c t + m \sin(\omega_m t))$$

$$= \cos(\omega_c t) \cos(m \sin(\omega_m t)) - \sin(\omega_c t) \sin(m \sin(\omega_m t))$$

$x(t)$ is periodic in $T = \frac{2\pi}{\omega_m}$, therefore $\cos(m \sin(\omega_m t))$ is periodic in T .

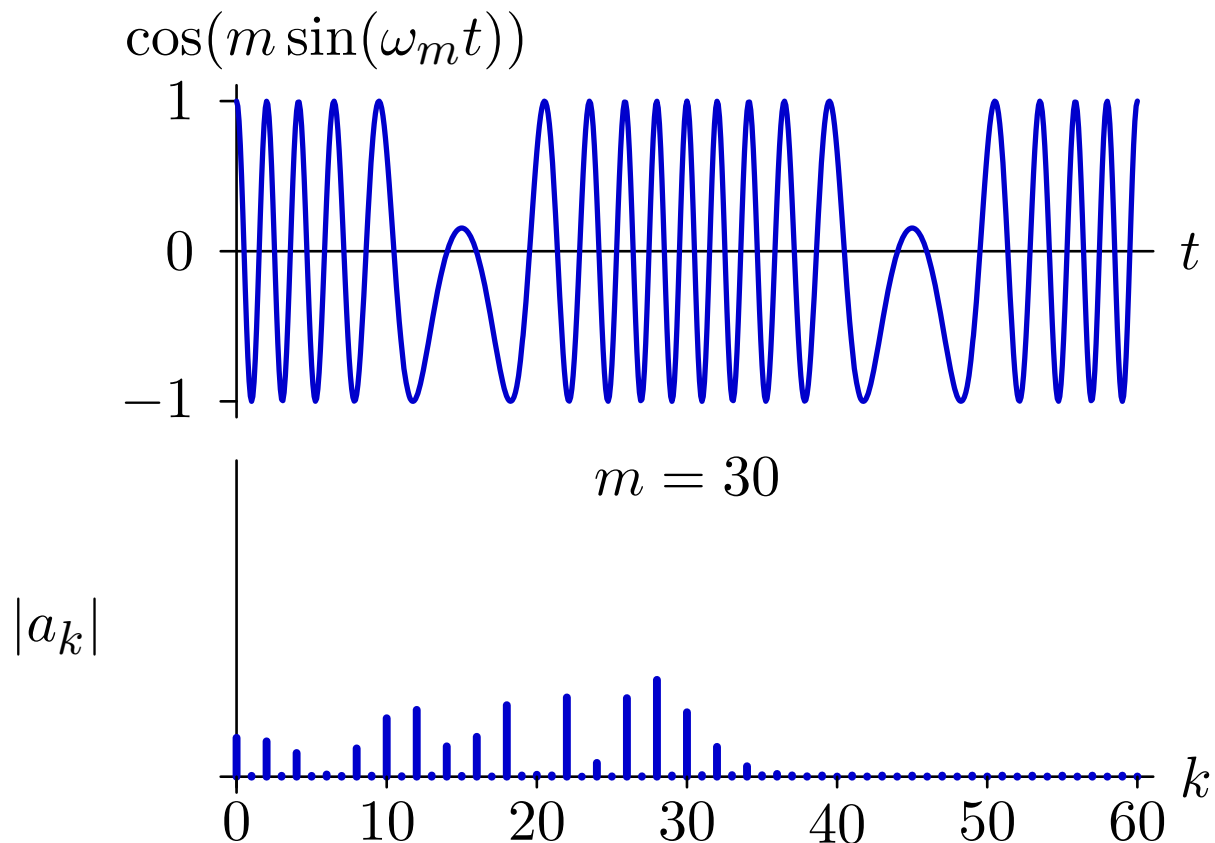

Phase/Frequency Modulation

Find the Fourier transform of a PM signal.

$$x(t) = \sin(\omega_m t)$$

$$y(t) = \cos(\omega_c t + m x(t)) = \cos(\omega_c t + m \sin(\omega_m t))$$

$$= \cos(\omega_c t) \cos(m \sin(\omega_m t)) - \sin(\omega_c t) \sin(m \sin(\omega_m t))$$

$x(t)$ is periodic in $T = \frac{2\pi}{\omega_m}$, therefore $\cos(m \sin(\omega_m t))$ is periodic in T .

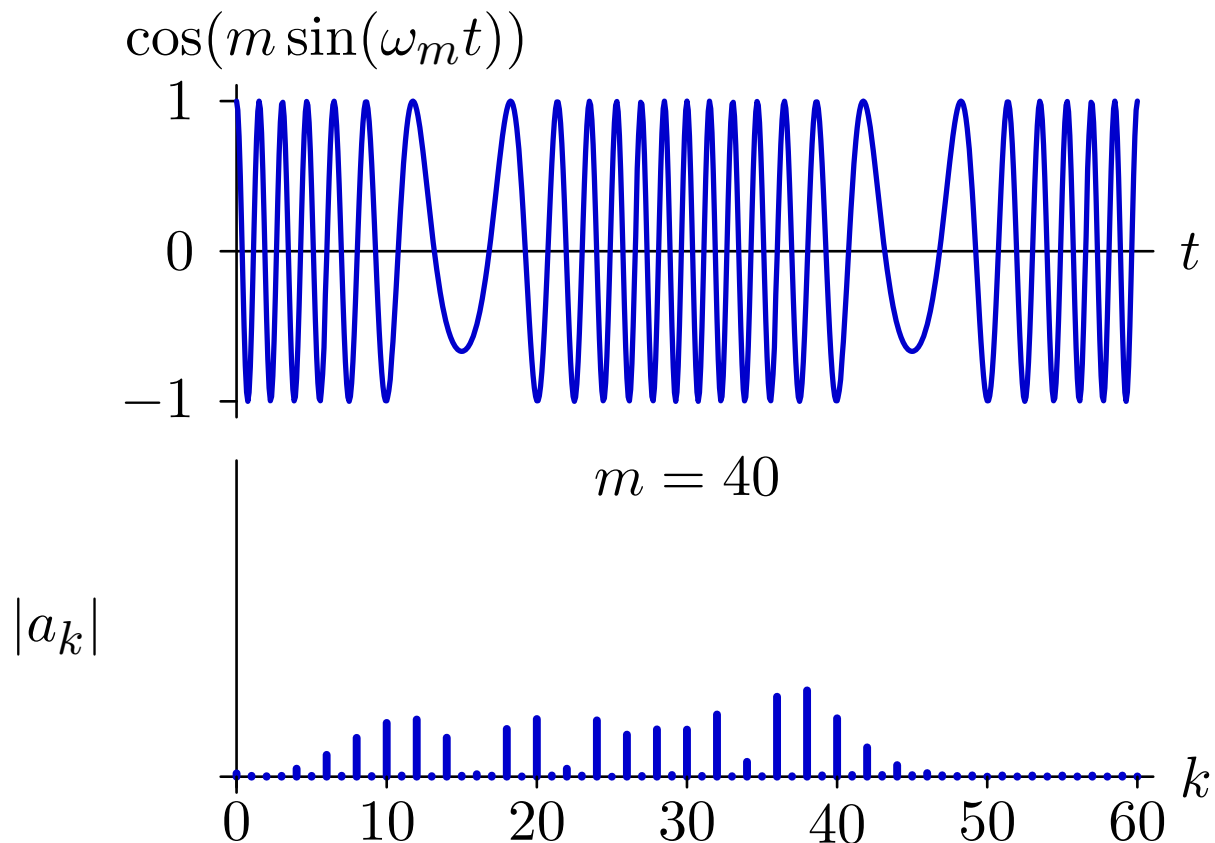

Phase/Frequency Modulation

Find the Fourier transform of a PM signal.

$$x(t) = \sin(\omega_m t)$$

$$y(t) = \cos(\omega_c t + mx(t)) = \cos(\omega_c t + m \sin(\omega_m t))$$

$$= \cos(\omega_c t) \cos(m \sin(\omega_m t)) - \sin(\omega_c t) \sin(m \sin(\omega_m t))$$

$x(t)$ is periodic in $T = \frac{2\pi}{\omega_m}$, therefore $\cos(m \sin(\omega_m t))$ is periodic in T .

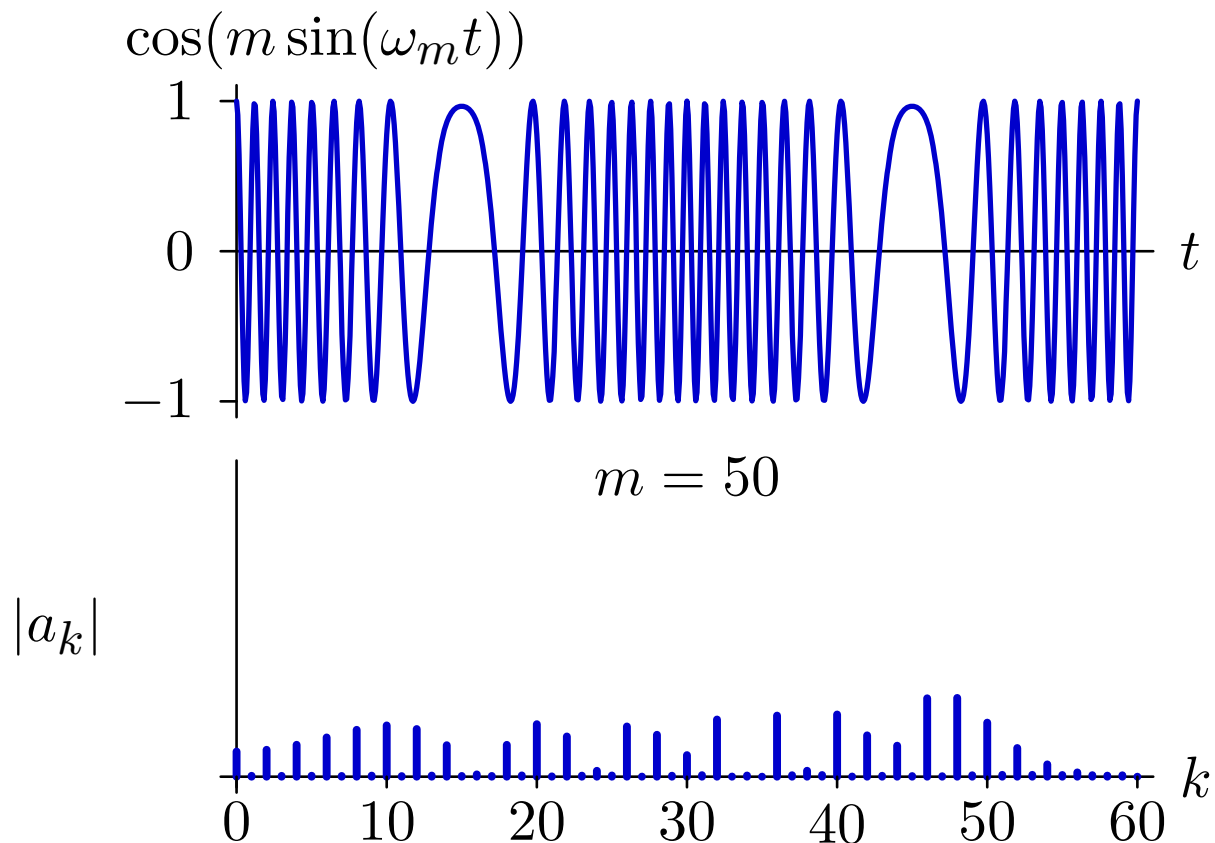

Phase/Frequency Modulation

Fourier transform of first part.

$$x(t) = \sin(\omega_m t)$$

$$y(t) = \cos(\omega_c t + m x(t)) = \cos(\omega_c t + m \sin(\omega_m t))$$

$$= \underbrace{\cos(\omega_c t) \cos(m \sin(\omega_m t))}_{y_a(t)} - \sin(\omega_c t) \sin(m \sin(\omega_m t))$$

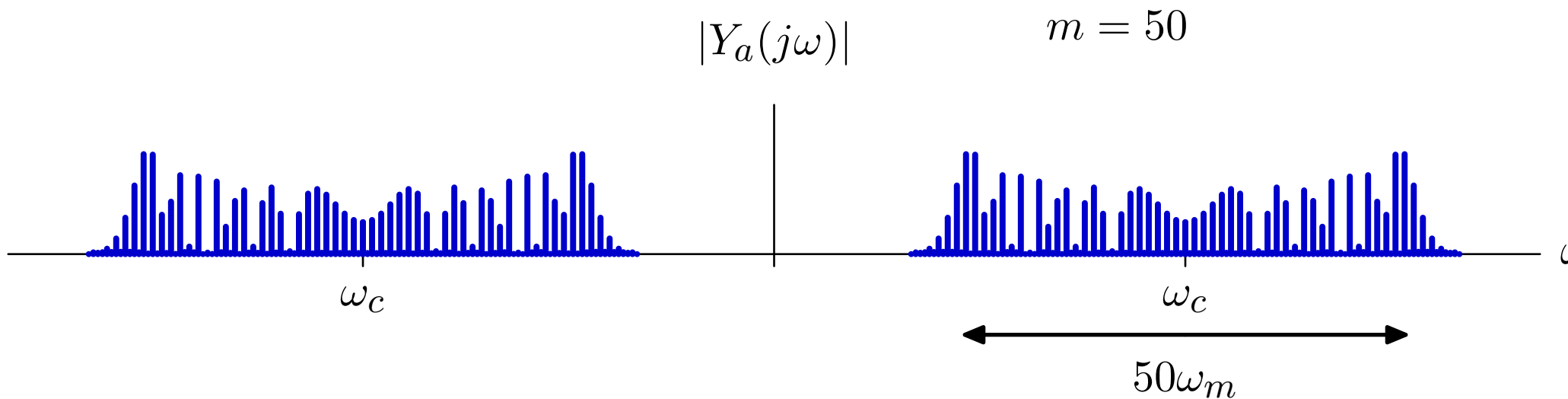

Phase/Frequency Modulation

Find the Fourier transform of a PM signal.

$$x(t) = \sin(\omega_m t)$$

$$y(t) = \cos(\omega_c t + m x(t)) = \cos(\omega_c t + m \sin(\omega_m t))$$

$$= \cos(\omega_c t) \cos(m \sin(\omega_m t)) - \sin(\omega_c t) \sin(m \sin(\omega_m t))$$

$x(t)$ is periodic in $T = \frac{2\pi}{\omega_m}$, therefore $\sin(m \sin(\omega_m t))$ is periodic in T .

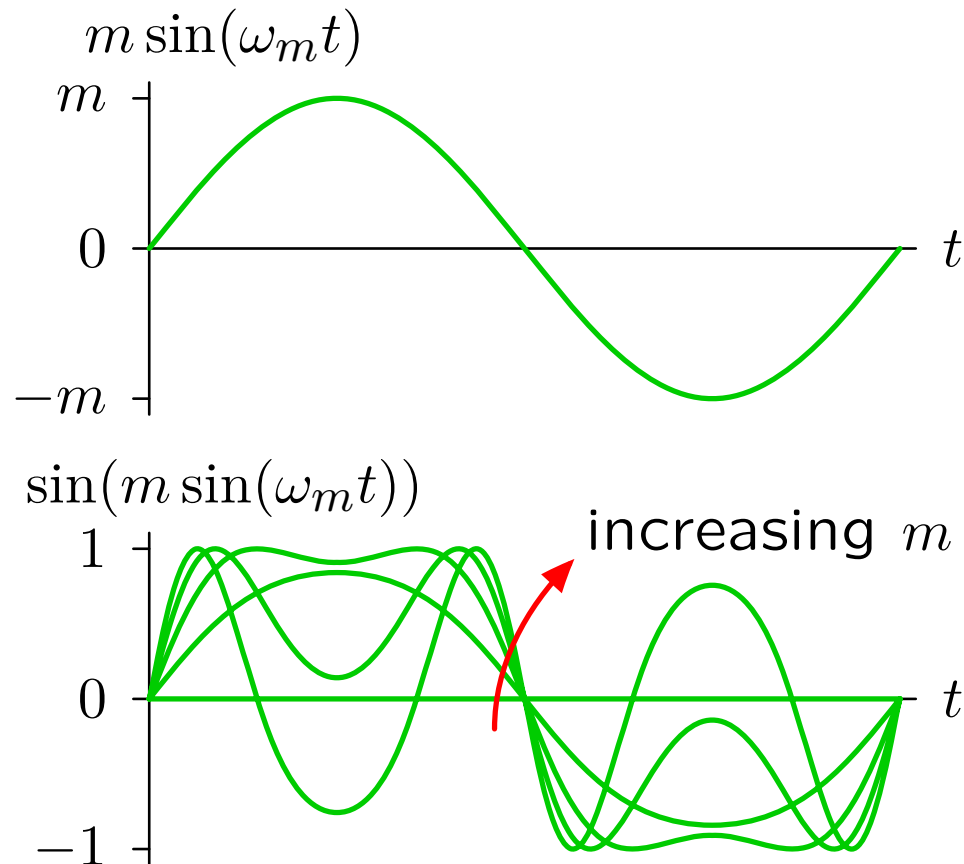

Phase/Frequency Modulation

Find the Fourier transform of a PM signal.

$$x(t) = \sin(\omega_m t)$$

$$y(t) = \cos(\omega_c t + m x(t)) = \cos(\omega_c t + m \sin(\omega_m t))$$

$$= \cos(\omega_c t) \cos(m \sin(\omega_m t)) - \sin(\omega_c t) \sin(m \sin(\omega_m t))$$

$x(t)$ is periodic in $T = \frac{2\pi}{\omega_m}$, therefore $\sin(m \sin(\omega_m t))$ is periodic in T .

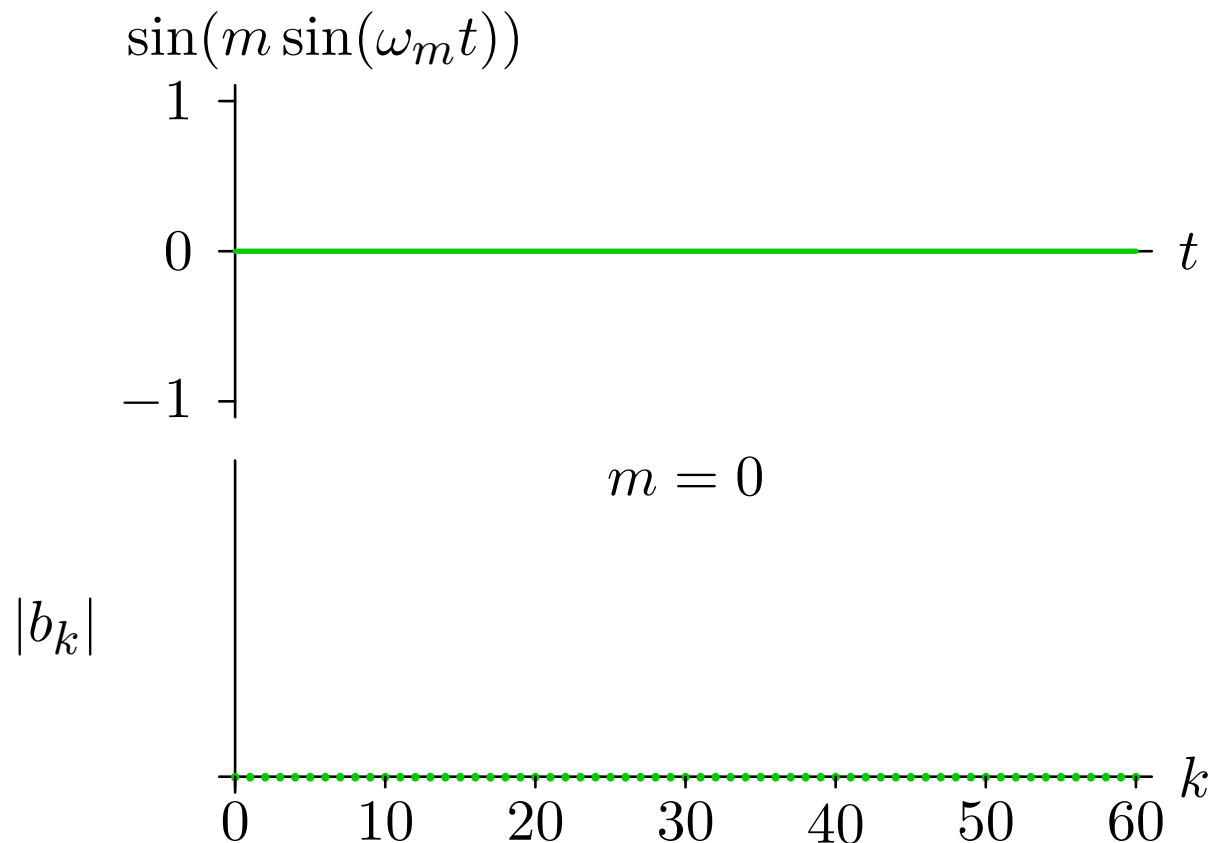

Phase/Frequency Modulation

Find the Fourier transform of a PM signal.

$$x(t) = \sin(\omega_m t)$$

$$y(t) = \cos(\omega_c t + m x(t)) = \cos(\omega_c t + m \sin(\omega_m t))$$

$$= \cos(\omega_c t) \cos(m \sin(\omega_m t)) - \sin(\omega_c t) \sin(m \sin(\omega_m t))$$

$x(t)$ is periodic in $T = \frac{2\pi}{\omega_m}$, therefore $\sin(m \sin(\omega_m t))$ is periodic in T .

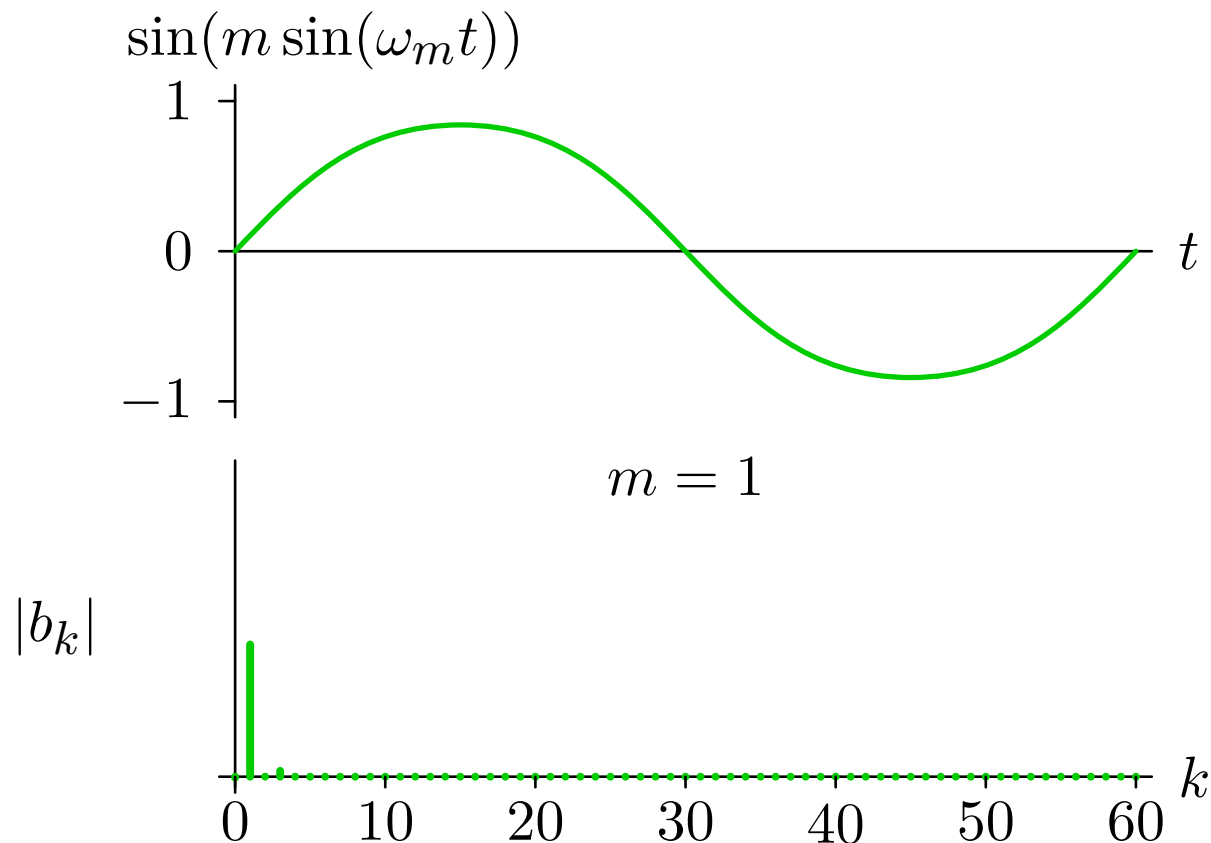

Phase/Frequency Modulation

Find the Fourier transform of a PM signal.

$$x(t) = \sin(\omega_m t)$$

$$y(t) = \cos(\omega_c t + mx(t)) = \cos(\omega_c t + m \sin(\omega_m t))$$

$$= \cos(\omega_c t) \cos(m \sin(\omega_m t)) - \sin(\omega_c t) \sin(m \sin(\omega_m t))$$

$x(t)$ is periodic in $T = \frac{2\pi}{\omega_m}$, therefore $\sin(m \sin(\omega_m t))$ is periodic in T .

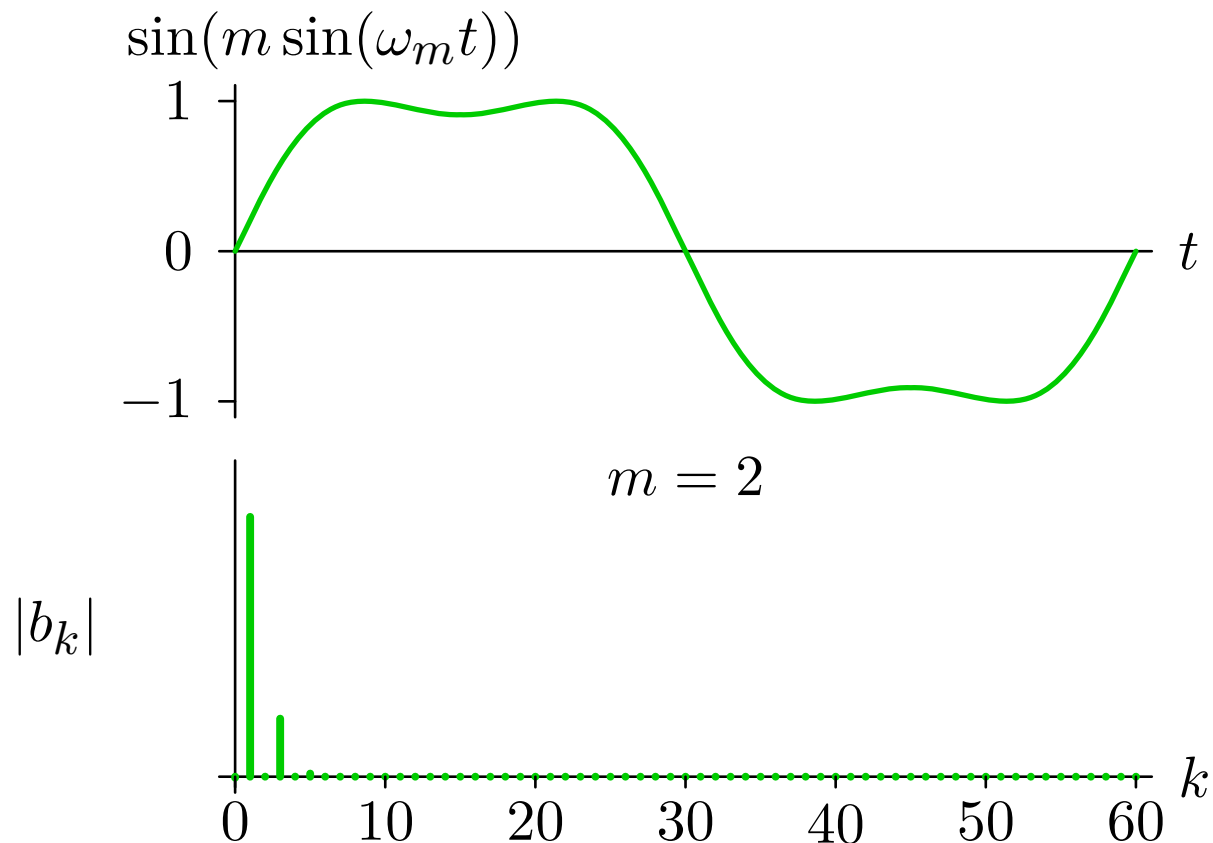

Phase/Frequency Modulation

Find the Fourier transform of a PM signal.

$$x(t) = \sin(\omega_m t)$$

$$y(t) = \cos(\omega_c t + m x(t)) = \cos(\omega_c t + m \sin(\omega_m t))$$

$$= \cos(\omega_c t) \cos(m \sin(\omega_m t)) - \sin(\omega_c t) \sin(m \sin(\omega_m t))$$

$x(t)$ is periodic in $T = \frac{2\pi}{\omega_m}$, therefore $\sin(m \sin(\omega_m t))$ is periodic in T .

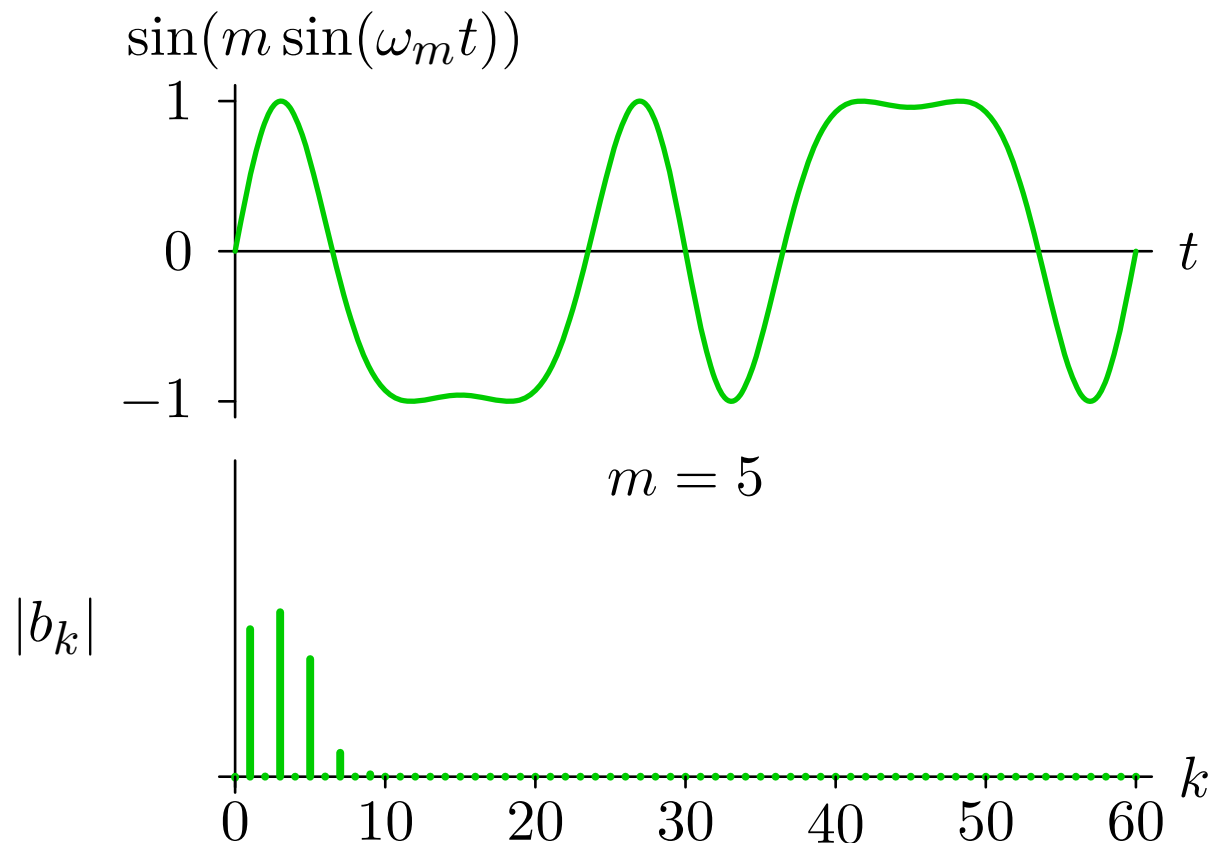

Phase/Frequency Modulation

Find the Fourier transform of a PM signal.

$$x(t) = \sin(\omega_m t)$$

$$y(t) = \cos(\omega_c t + m x(t)) = \cos(\omega_c t + m \sin(\omega_m t))$$

$$= \cos(\omega_c t) \cos(m \sin(\omega_m t)) - \sin(\omega_c t) \sin(m \sin(\omega_m t))$$

$x(t)$ is periodic in $T = \frac{2\pi}{\omega_m}$, therefore $\sin(m \sin(\omega_m t))$ is periodic in T .

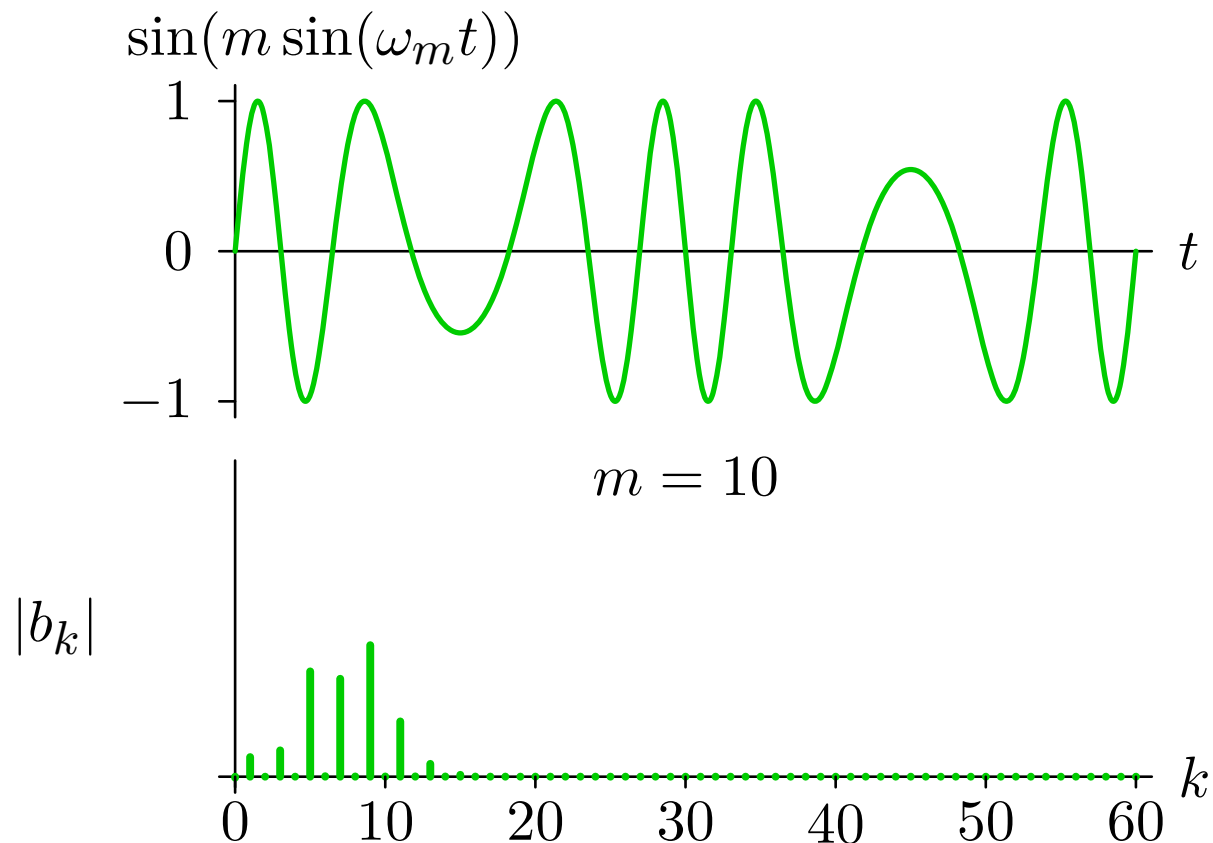

Phase/Frequency Modulation

Find the Fourier transform of a PM signal.

$$x(t) = \sin(\omega_m t)$$

$$y(t) = \cos(\omega_c t + m x(t)) = \cos(\omega_c t + m \sin(\omega_m t))$$

$$= \cos(\omega_c t) \cos(m \sin(\omega_m t)) - \sin(\omega_c t) \sin(m \sin(\omega_m t))$$

$x(t)$ is periodic in $T = \frac{2\pi}{\omega_m}$, therefore $\sin(m \sin(\omega_m t))$ is periodic in T .

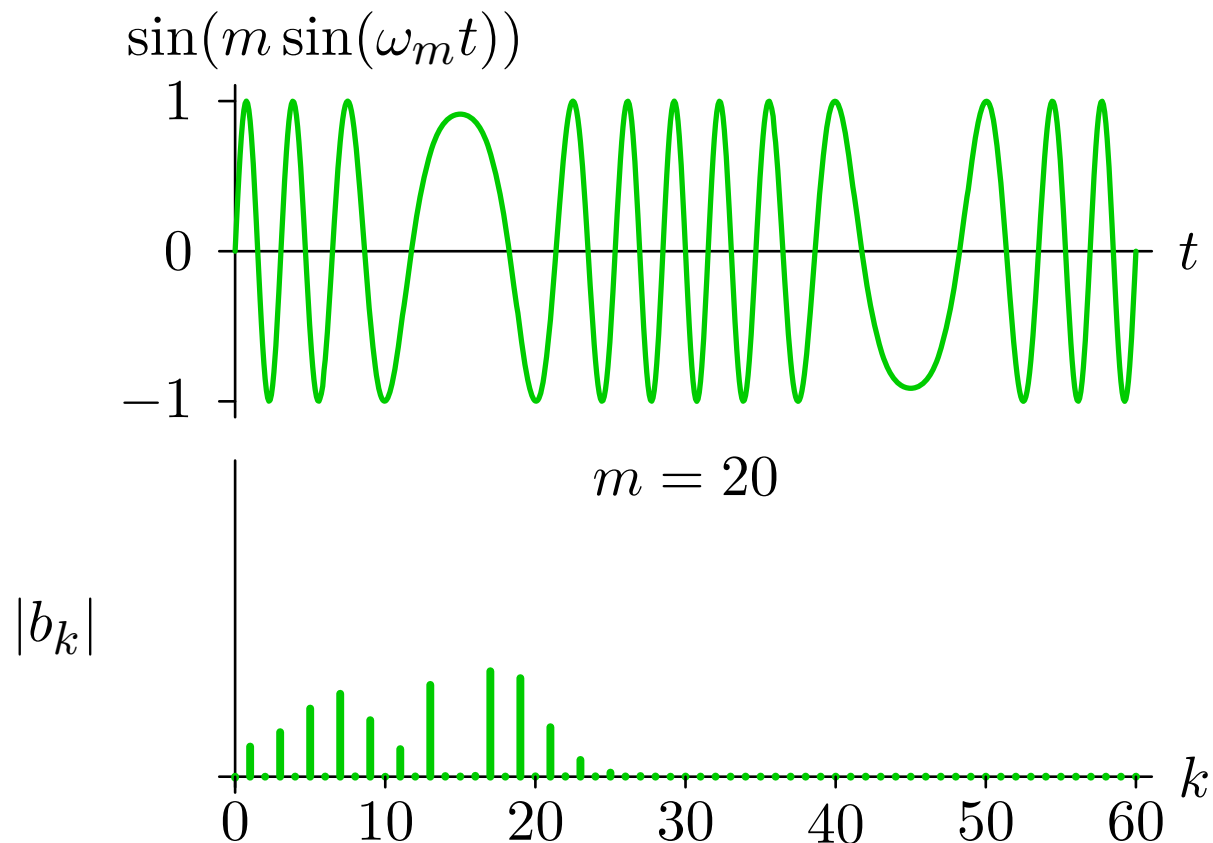

Phase/Frequency Modulation

Find the Fourier transform of a PM signal.

$$x(t) = \sin(\omega_m t)$$

$$y(t) = \cos(\omega_c t + mx(t)) = \cos(\omega_c t + m \sin(\omega_m t))$$

$$= \cos(\omega_c t) \cos(m \sin(\omega_m t)) - \sin(\omega_c t) \sin(m \sin(\omega_m t))$$

$x(t)$ is periodic in $T = \frac{2\pi}{\omega_m}$, therefore $\sin(m \sin(\omega_m t))$ is periodic in T .

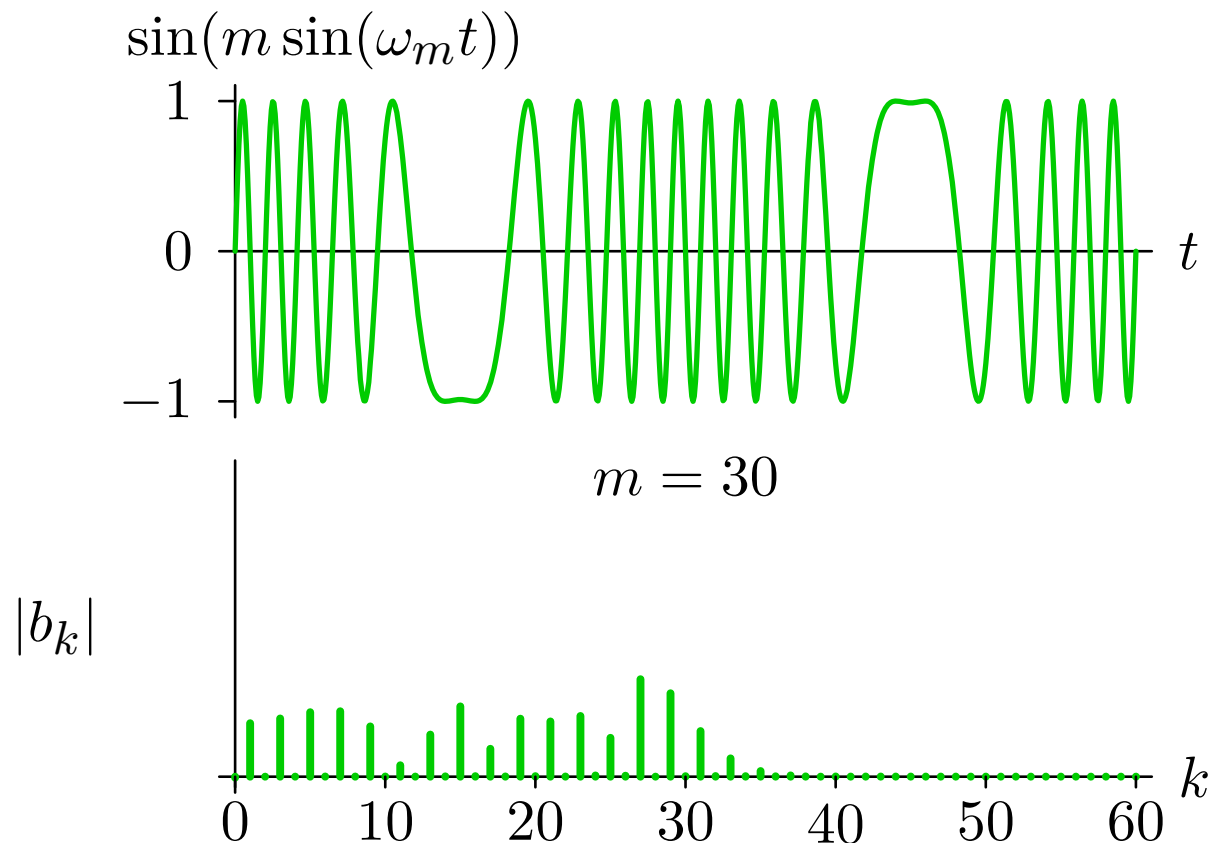

Phase/Frequency Modulation

Find the Fourier transform of a PM signal.

$$x(t) = \sin(\omega_m t)$$

$$y(t) = \cos(\omega_c t + m x(t)) = \cos(\omega_c t + m \sin(\omega_m t))$$

$$= \cos(\omega_c t) \cos(m \sin(\omega_m t)) - \sin(\omega_c t) \sin(m \sin(\omega_m t))$$

$x(t)$ is periodic in $T = \frac{2\pi}{\omega_m}$, therefore $\sin(m \sin(\omega_m t))$ is periodic in T .

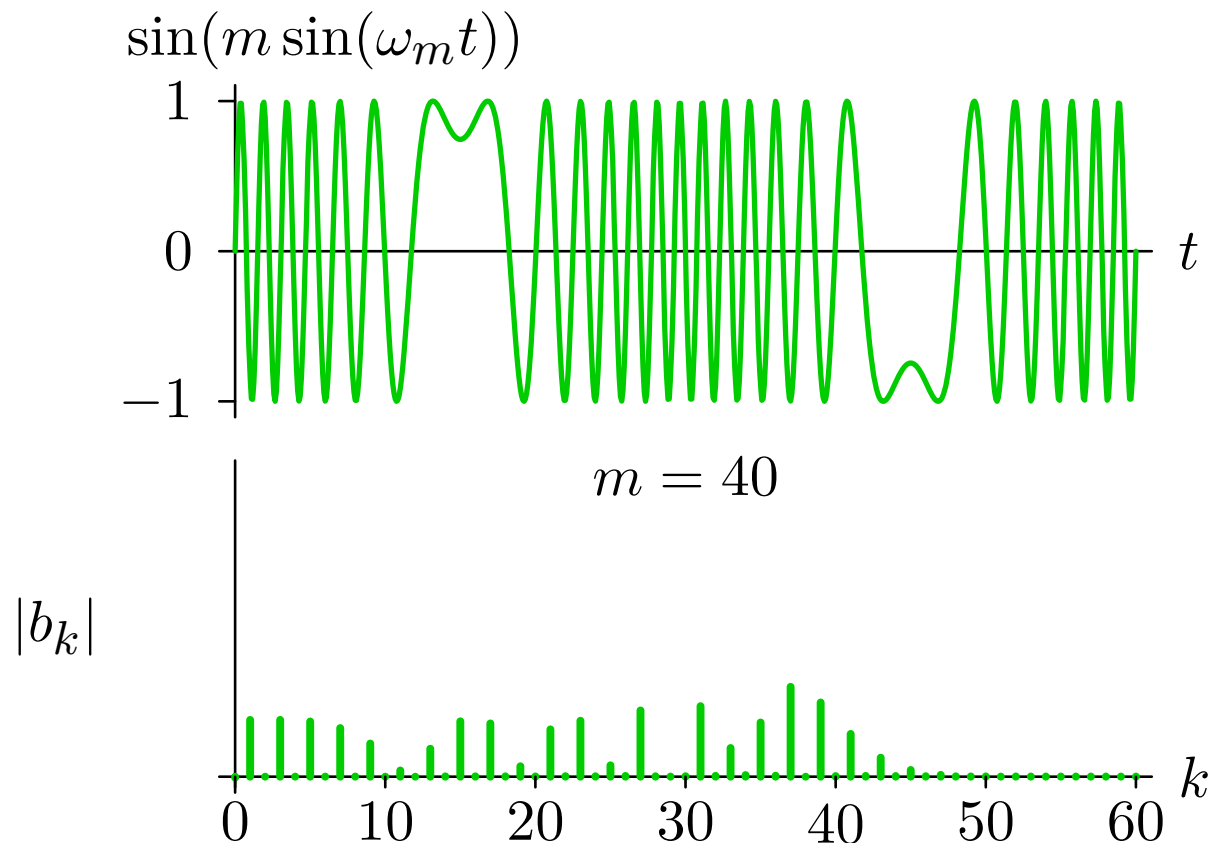

Phase/Frequency Modulation

Find the Fourier transform of a PM signal.

$$x(t) = \sin(\omega_m t)$$

$$y(t) = \cos(\omega_c t + m x(t)) = \cos(\omega_c t + m \sin(\omega_m t))$$

$$= \cos(\omega_c t) \cos(m \sin(\omega_m t)) - \sin(\omega_c t) \sin(m \sin(\omega_m t))$$

$x(t)$ is periodic in $T = \frac{2\pi}{\omega_m}$, therefore $\sin(m \sin(\omega_m t))$ is periodic in T .

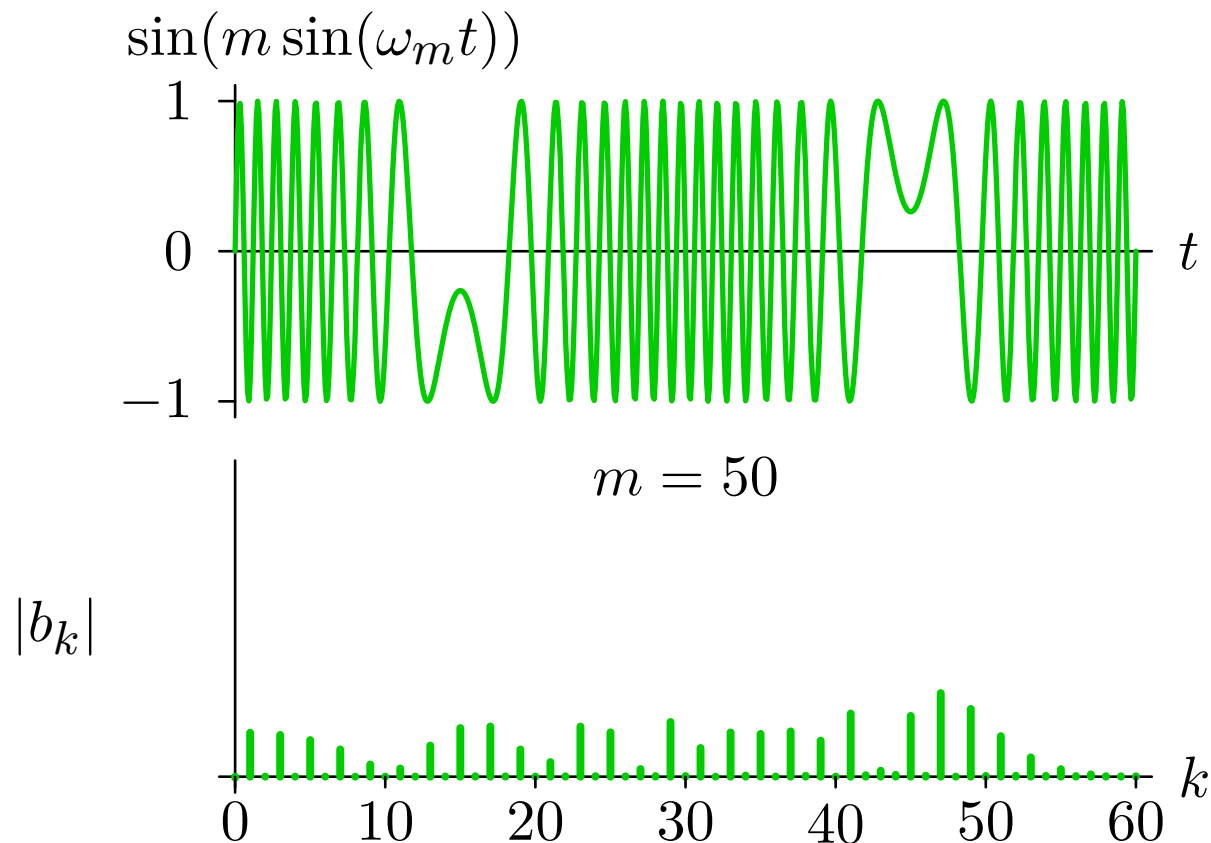

Phase/Frequency Modulation

Fourier transform of second part.

$$x(t) = \sin(\omega_m t)$$

$$y(t) = \cos(\omega_c t + mx(t)) = \cos(\omega_c t + m \sin(\omega_m t))$$

$$= \cos(\omega_c t) \cos(m \sin(\omega_m t)) - \underbrace{\sin(\omega_c t) \sin(m \sin(\omega_m t))}_{y_b(t)}$$

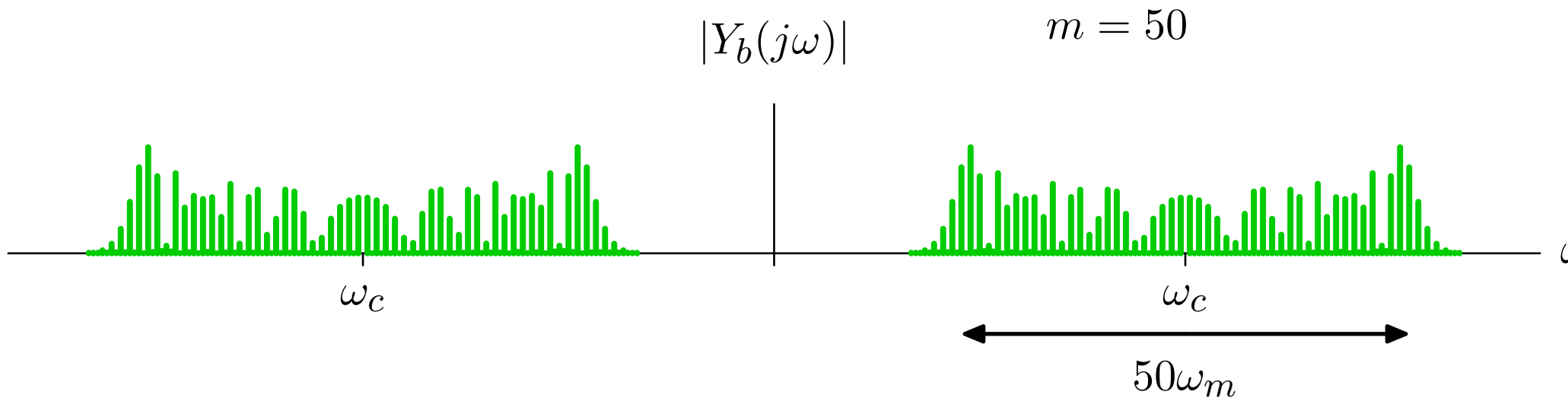

Phase/Frequency Modulation

Fourier transform.

$$x(t) = \sin(\omega_m t)$$

$$y(t) = \cos(\omega_c t + mx(t)) = \cos(\omega_c t + m \sin(\omega_m t))$$

$$= \underbrace{\cos(\omega_c t) \cos(m \sin(\omega_m t))}_{y_a(t)} - \underbrace{\sin(\omega_c t) \sin(m \sin(\omega_m t))}_{y_b(t)}$$

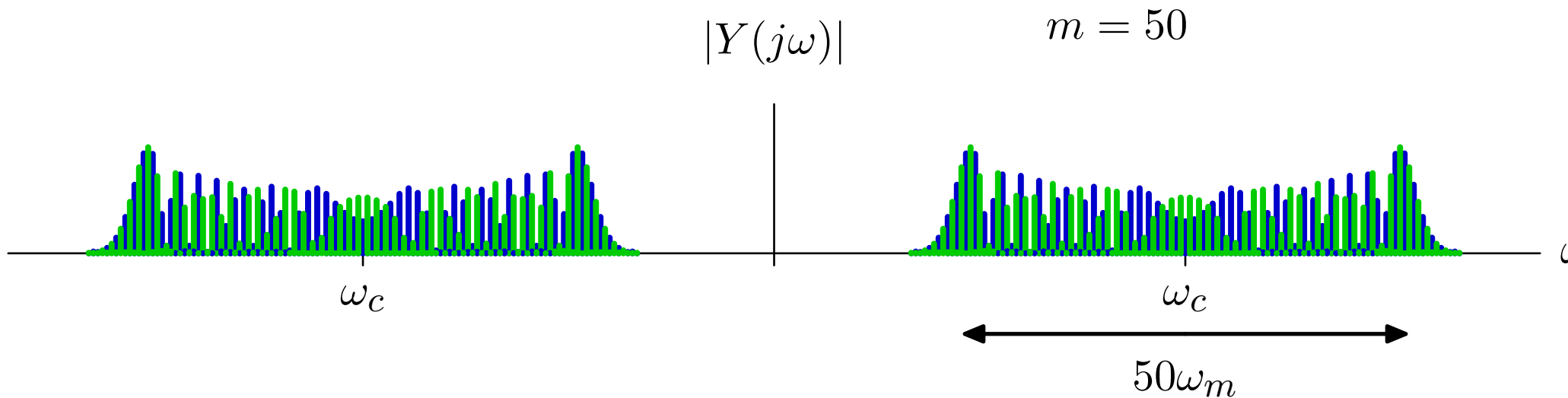

Frequency Modulation

Wideband FM is useful because it is robust to noise.

$$\text{AM: } y_1(t) = (\cos(\omega_m t) + 1.1) \cos(\omega_c t)$$

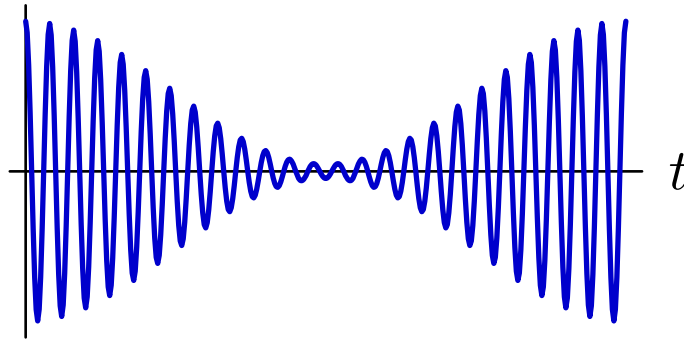

$$\text{FM: } y_3(t) = \cos(\omega_c t + m \sin(\omega_m t))$$

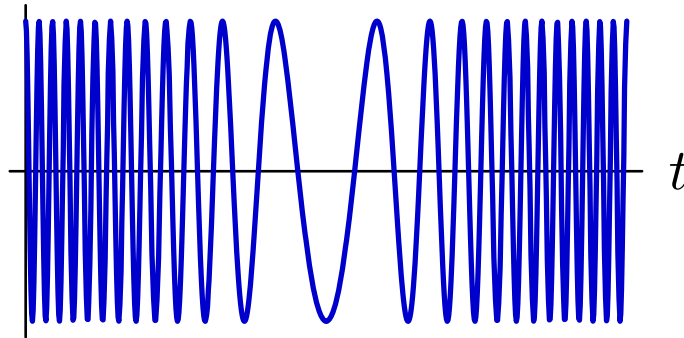

FM generates a very redundant signal, which is resilient to additive noise.

Summary

Modulation is useful for matching signals to media.

Examples: commercial radio (AM and FM)

Close with unconventional application of modulation – in microscopy.

MIT OpenCourseWare
<http://ocw.mit.edu>

6.003 Signals and Systems
Spring 2010

For information about citing these materials or our Terms of Use, visit: <http://ocw.mit.edu/terms>.